



**Shenzhen Wellgo Technology Co., Ltd.**

Professional battery accessories manufacturer

E-mail: ken@wellgobattery.com Wechat Or Whatsapp: (86)18038053100

Name	Type	Center distance	Product material	Matching bracket
18650 Nickel Sheet	2P-6P	18.5mm	Plated Nickel or Pure Nickel	Suitable for <b>no bracket</b>

Product Image

Product Size (mm)

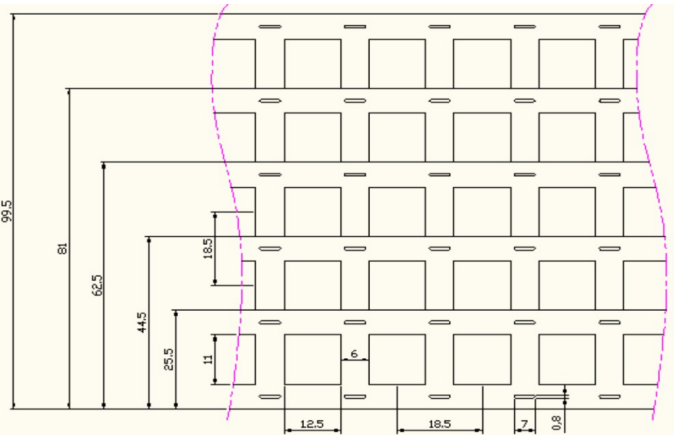
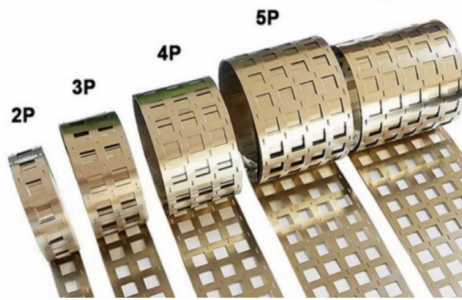

Remark

Material thickness optional: 0.1mm; 0.15mm; 0.2mm

Name	Type	Center distance	Product material	Matching bracket
18650 Nickel Sheet	2P-7P	20.25mm	Plated Nickel or Pure Nickel	Suitable for <b>with Bracket</b>

Product Image

Product Size (mm)

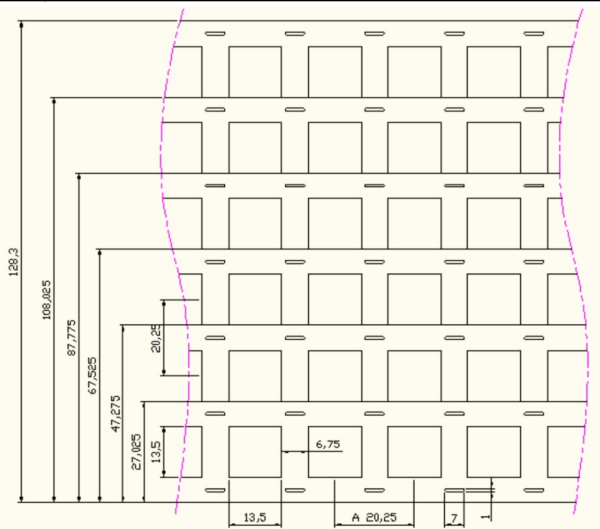
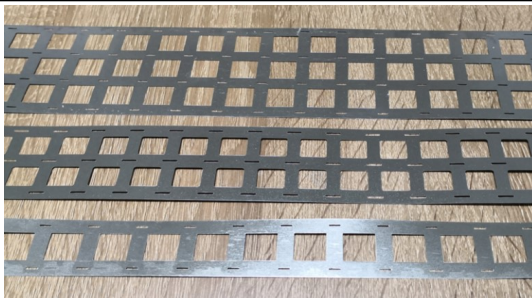

Remark

Material thickness optional: 0.1mm; 0.15mm; 0.2mm

Name	Type	Center distance	Product material	Matching bracket
18650 Nickel Sheet	Honeycomb-2P	18.5mm	Plated Nickel or Pure Nickel	Suitable for <b>NO Bracket</b>

Product Image

Product Size (mm)

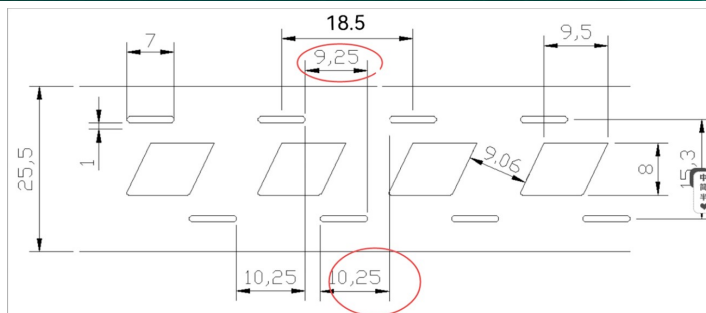

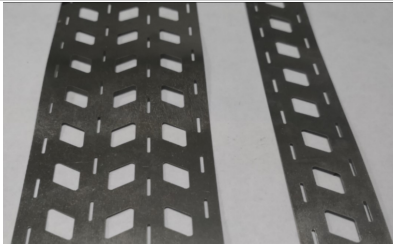
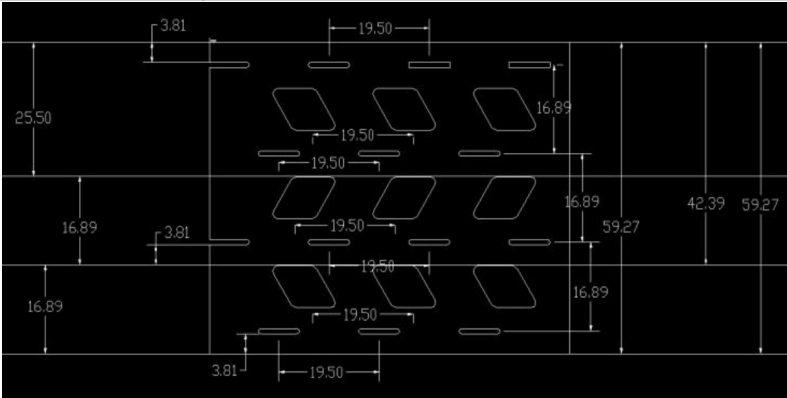

Remark

Material thickness optional: 0.1mm; 0.15mm; 0.2mm

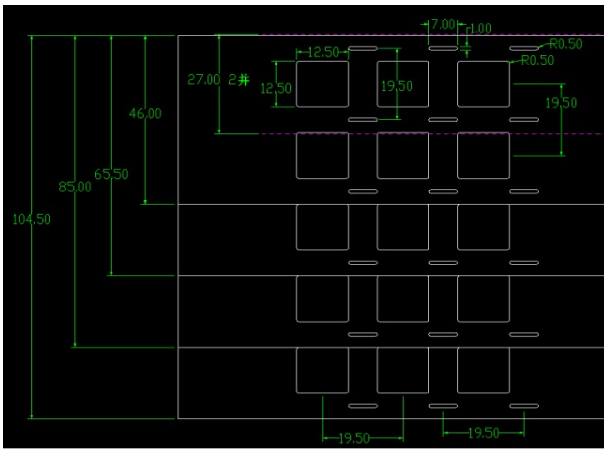
Name	Type	Center distance	Product material	Matching bracket
18650 Nickel Sheet	Honeycomb-2P~4P	19.5mm	Plated Nickel or Pure Nickel	Suitable for Honeycomb Bracket
Product Image			Product Size (mm)	
				
Remark	Material thickness optional: 0.1mm; 0.15mm; 0.2mm			

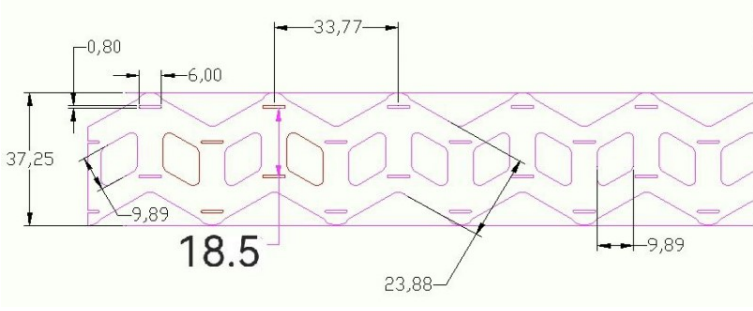
Name	Type	Center distance	Product material	Matching bracket
18650 Nickel Sheet	2P 3P 4P	19.5mm	Plated Nickel or Pure Nickel	Suitable for With Bracket
Product Image			Product Size (mm)	
				
Remark	Material thickness optional: 0.1mm; 0.15mm; 0.2mm			

Name	Type	Center distance	Product material	Matching bracket
18650 Nickel Sheet	"W" type 2P	18.5mm	Plated Nickel or Pure Nickel	Suitable for No Bracket
Product Image			Product Size (mm)	
				
Remark	Material thickness optional: 0.1mm; 0.15mm; 0.2mm			

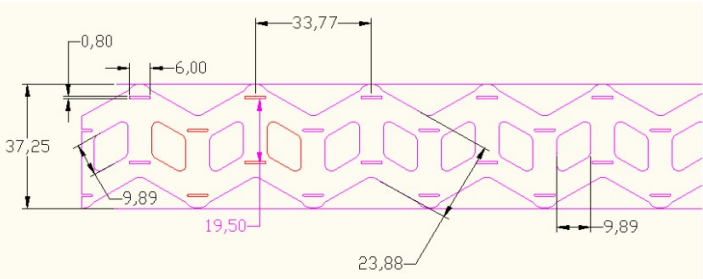
Name	Type	Center distance	Product material	Matching bracket
18650 Nickel Sheet	"W" type 2P	19.5mm	Plated Nickel or Pure Nickel	Suitable for With Bracket
Product Image			Product Size (mm)	
				
Remark	Material thickness optional: 0.1mm; 0.15mm; 0.2mm			

Name	Type	Center distance	Product material	Matching bracket
18650 Nickel Sheet	"T" type ;"Y" type	18.5mm	Plated Nickel or Pure Nickel	Suitable for NO Bracket
Product Image			Product Size (mm)	

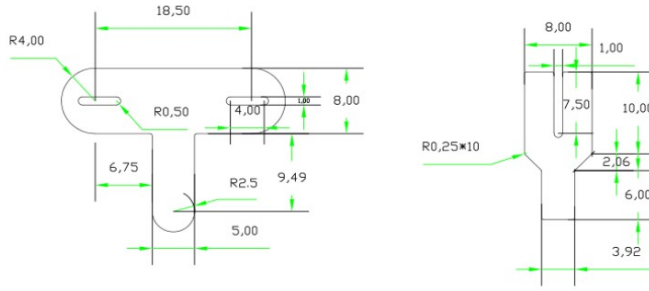

Remark	Material thickness optional: 0.1mm; 0.15mm; 0.2mm			
Name	Type	Center distance	Product material	Matching bracket
18650 Nickel Sheet	4P	18.3mm	Plated Nickel or Pure Nickel	Suitable for <b>NO Bracket</b>
Product Image		Product Size (mm)		

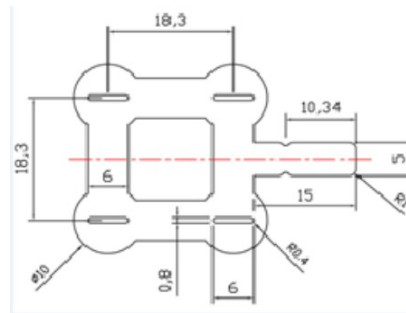
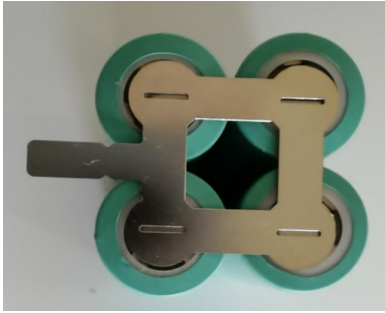

Remark	Material thickness optional: 0.1mm; 0.15mm; 0.2mm			
Name	Type	Center distance	Product material	Matching bracket
21700 Nickel Sheet	2P 3P 4P	21.5mm	Plated Nickel or Pure Nickel	Suitable for <b>NO Bracket</b>
Product Image		Product Size (mm)		

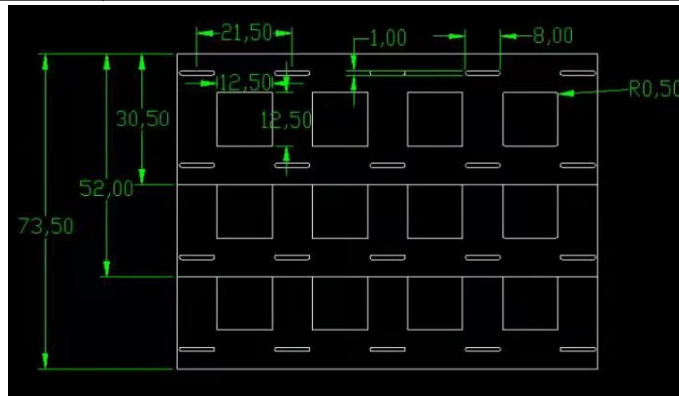
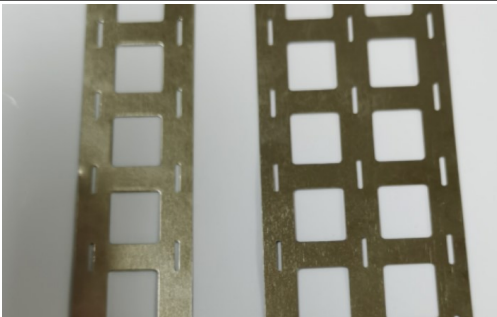

Remark	Material thickness optional: 0.1mm; 0.15mm; 0.2mm			
Name	Type	Center distance	Product material	Matching bracket
21700 Nickel Sheet	2P 3P 4P	23mm	Plated Nickel or Pure Nickel	Suitable for <b>With Bracket</b>
Product Image		Product Size (mm)		

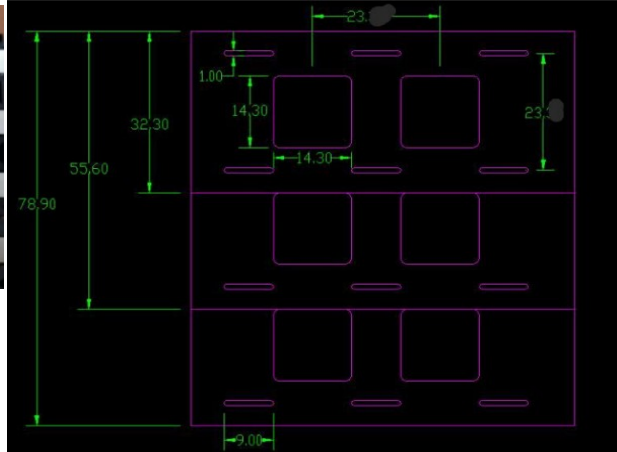
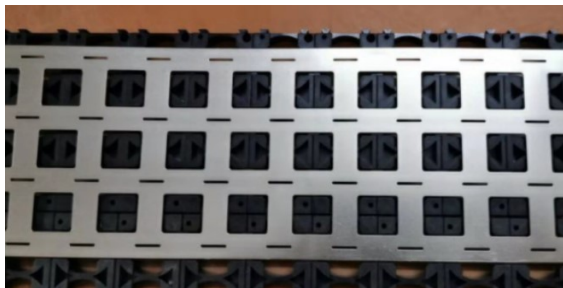

Remark	Material thickness optional: 0.1mm; 0.15mm; 0.2mm. Suitable for battery holder with hole diameter of 21.2mm			
Name	Type	Center distance	Product material	Matching bracket
21700 Nickel Sheet	2P 3P 4P	23.3mm	Plated Nickel or Pure Nickel	Suitable for <b>With Bracket</b>
Product Image		Product Size (mm)		



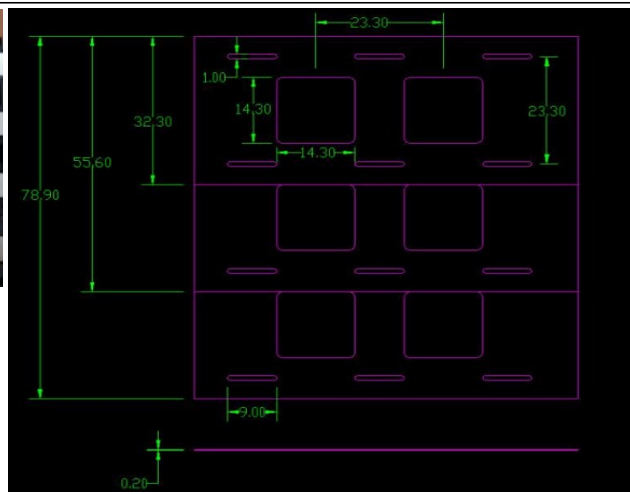
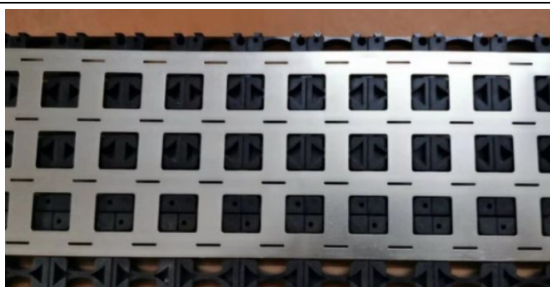

<b>Remark</b>	Material thickness optional: 0.1mm; 0.15mm; 0.2mm. Suitable for battery holder with hole diameter of 21.7mm			
<b>Name</b>	<b>Type</b>	<b>Center distance</b>	<b>Product material</b>	<b>Matching bracket</b>
21700 Nickel Sheet	Honeycomb-2P 3P 4P	22.7mm	Plated Nickel or Pure Nickel	Suitable for <b>Honeycomb Bracket</b>
Product Image		Product Size (mm)		

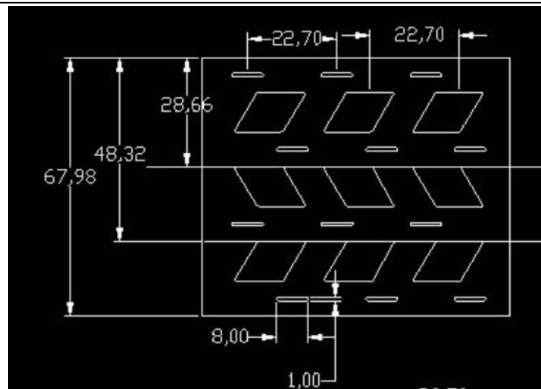
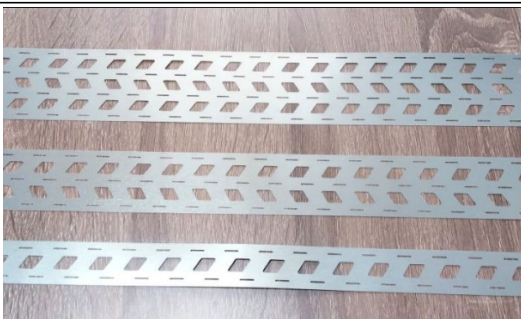

<b>Remark</b>	Material thickness optional: 0.1mm; 0.15mm; 0.2mm.			
<b>Name</b>	<b>Type</b>	<b>Center distance</b>	<b>Product material</b>	<b>Matching bracket</b>
21700 Nickel Sheet	Honeycomb-2P	21.5mm	Plated Nickel or Pure Nickel	Suitable for <b>NO Bracket</b>
Product Image		Product Size (mm)		

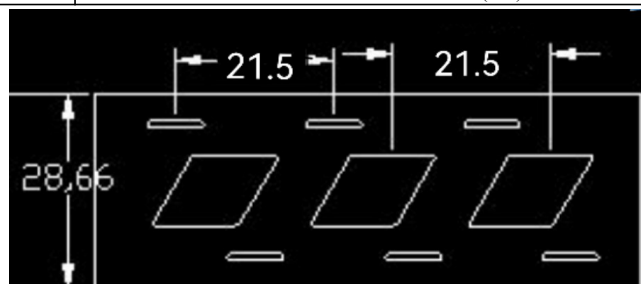
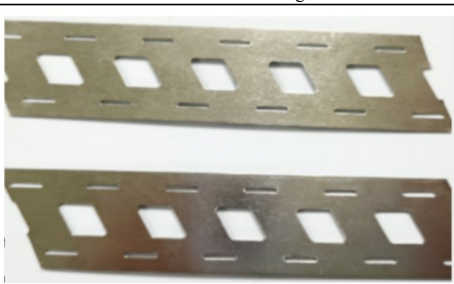

<b>Remark</b>	Material thickness optional: 0.1mm; 0.15mm; 0.2mm.			
<b>Name</b>	<b>Type</b>	<b>Center distance</b>	<b>Product material</b>	<b>Matching bracket</b>
21700 Nickel Sheet	"W" type 2P	22.7mm	Plated Nickel or Pure Nickel	Suitable for <b>Honeycomb Bracket</b>
Product Image		Product Size (mm)		

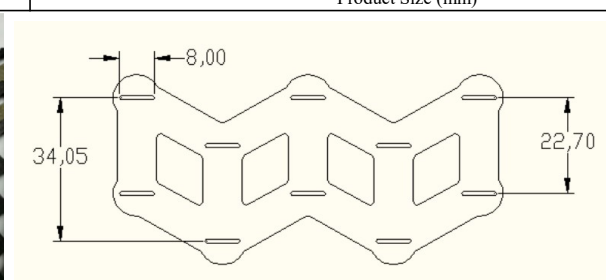

<b>Remark</b>	Material thickness optional: 0.1mm; 0.15mm; 0.2mm.			
<b>Name</b>	<b>Type</b>	<b>Center distance</b>	<b>Product material</b>	<b>Matching bracket</b>
21700 Nickel Sheet	"W" type 2P	21.5mm	Plated Nickel or Pure Nickel	Suitable for <b>NO Bracket</b>
Product Image		Product Size (mm)		

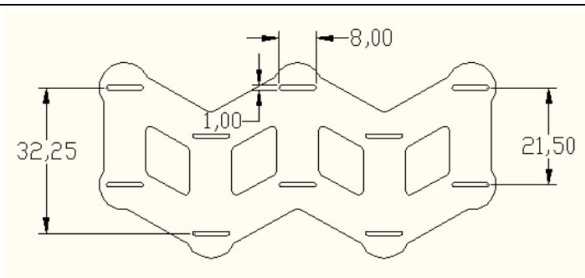
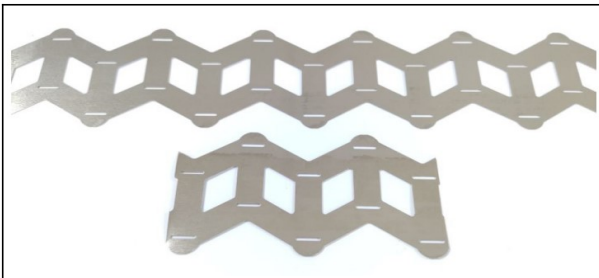

<b>Remark</b>	<b>Material thickness optional: 0.1mm; 0.15mm; 0.2mm.</b>			
<b>Name</b>	<b>Type</b>	<b>Center distance</b>	<b>Product material</b>	<b>Matching bracket</b>
26650 Nickel Sheet	2P 3P 4P	28mm	Plated Nickel or Pure Nickel	Suitable for <b>With Bracket</b>
Product Image			Product Size (mm)	

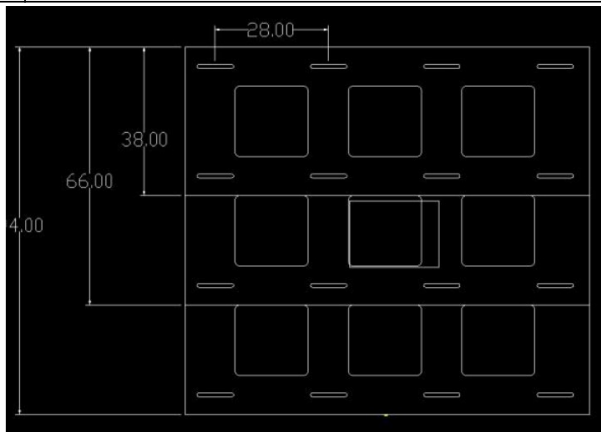

<b>Remark</b>	<b>Material thickness optional: 0.1mm; 0.15mm; 0.2mm.</b>			
<b>Name</b>	<b>Type</b>	<b>Center distance</b>	<b>Product material</b>	<b>Matching bracket</b>
26650 Nickel Sheet	2P	26.3mm	Plated Nickel or Pure Nickel	Suitable for <b>NO Bracket</b>
Product Image			Product Size (mm)	

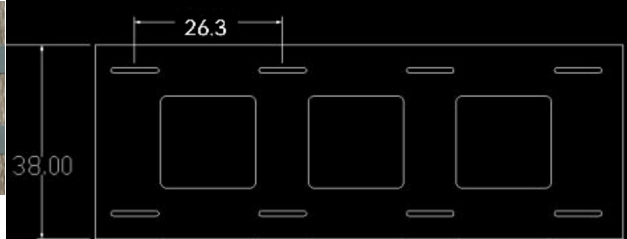

<b>Remark</b>	<b>Material thickness optional: 0.1mm; 0.15mm; 0.2mm. According to the picture, there is no side hole.</b>			
<b>Name</b>	<b>Type</b>	<b>Center distance</b>	<b>Product material</b>	<b>Matching bracket</b>
26650 Nickel Sheet	Honeycomb-2P	26.5mm	Plated Nickel or Pure Nickel	Suitable for <b>NO Bracket</b>
Product Image			Product Size (mm)	

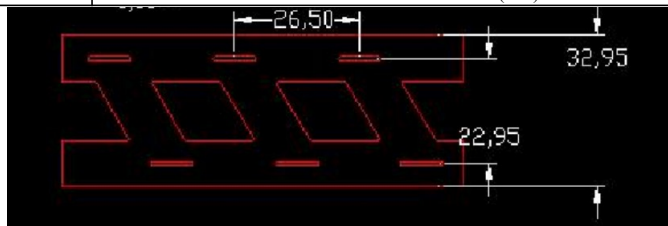

<b>Remark</b>	<b>Material thickness optional: 0.1mm; 0.15mm; 0.2mm.</b>			
<b>Name</b>	<b>Type</b>	<b>Center distance</b>	<b>Product material</b>	<b>Matching bracket</b>
32650 Nickel Sheet	Honeycomb-2P	32.5mm	Plated Nickel or Pure Nickel	Suitable for <b>NO Bracket</b>
Product Image			Product Size (mm)	

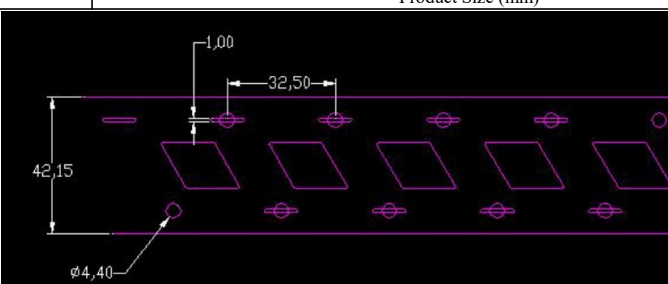
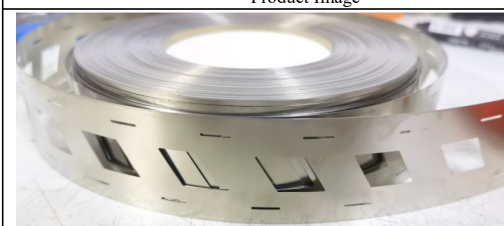

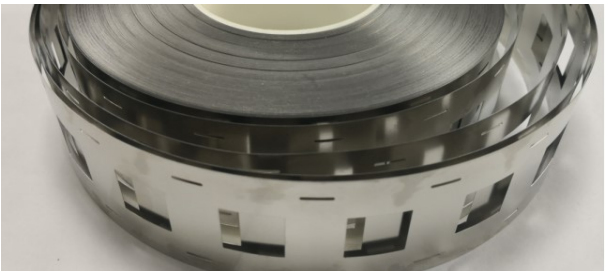
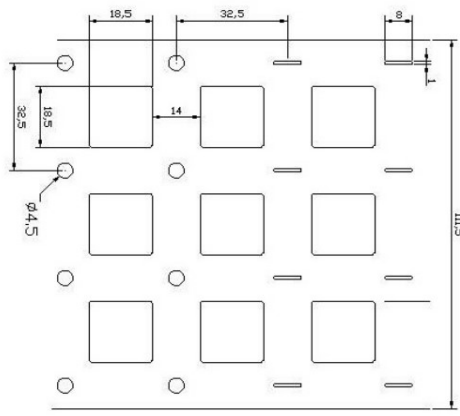
<b>Remark</b>	<b>Material thickness optional: 0.1mm; 0.15mm; 0.2mm. The spot welding position hole can choose oval hole or round hole.</b>			
<b>Name</b>	<b>Type</b>	<b>Center distance</b>	<b>Product material</b>	<b>Matching bracket</b>
32650 Nickel Sheet	2P 3P 4P	32.5mm	Plated Nickel or Pure Nickel	Suitable for <b>NO Bracket</b>
Product Image			Product Size (mm)	
				

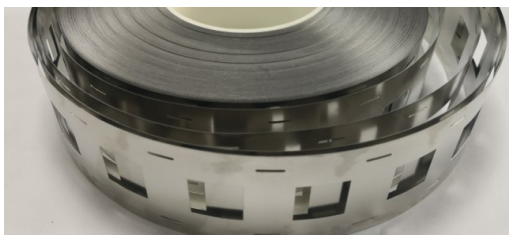
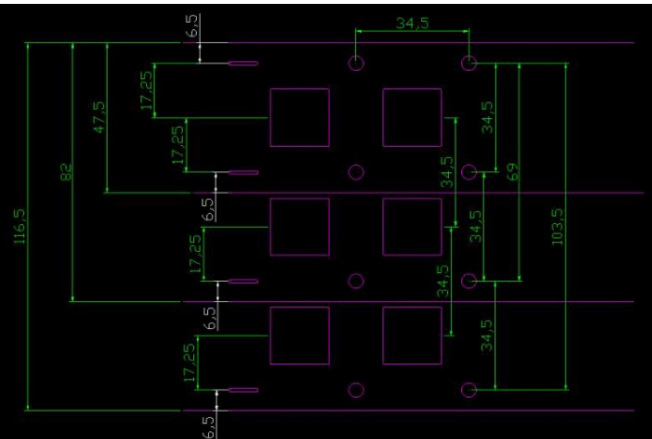
<b>Remark</b>	<b>Material thickness optional: 0.1mm; 0.15mm; 0.2mm. The spot welding position hole can choose oval hole or round hole.</b>			
<b>Name</b>	<b>Type</b>	<b>Center distance</b>	<b>Product material</b>	<b>Matching bracket</b>
32650 Nickel Sheet	2P 3P 4P	34.5mm	Plated Nickel or Pure Nickel	Suitable for <b>With Bracket</b>
Product Image			Product Size (mm)	
				

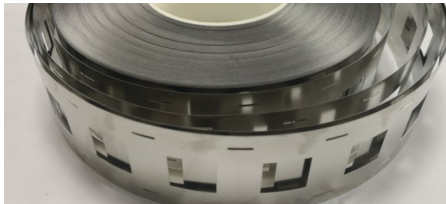
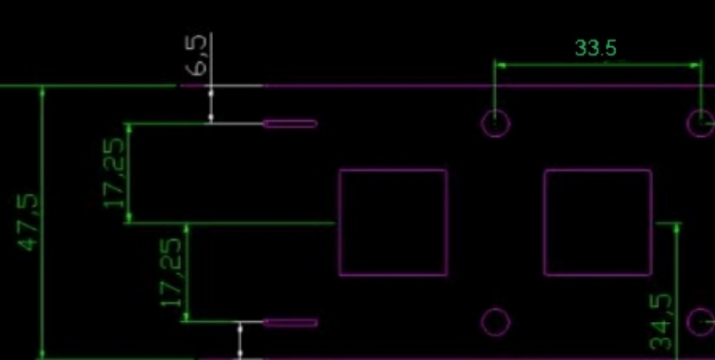
<b>Remark</b>	<b>Material thickness optional: 0.1mm; 0.15mm; 0.2mm. The spot welding position hole can choose oval hole or round hole.</b>			
<b>Name</b>	<b>Type</b>	<b>Center distance</b>	<b>Product material</b>	<b>Matching bracket</b>
33135 Nickel Sheet	2P	33.5mm	Plated Nickel/Pure Nickel/Copper	Suitable for <b>NO Bracket</b>
Product Image			Product Size (mm)	
				

<b>Remark</b>	<b>Material thickness optional: 0.1mm; 0.15mm; 0.2mm. Suitable for 32135/33135/33140 cell.</b>			
<b>Name</b>	<b>Type</b>	<b>Center distance</b>	<b>Product material</b>	<b>Matching bracket</b>
33135 Nickel Sheet	2P	35mm	Plated Nickel/Pure Nickel/Copper	Suitable for <b>With Bracket</b>
Product Image			Product Size (mm)	

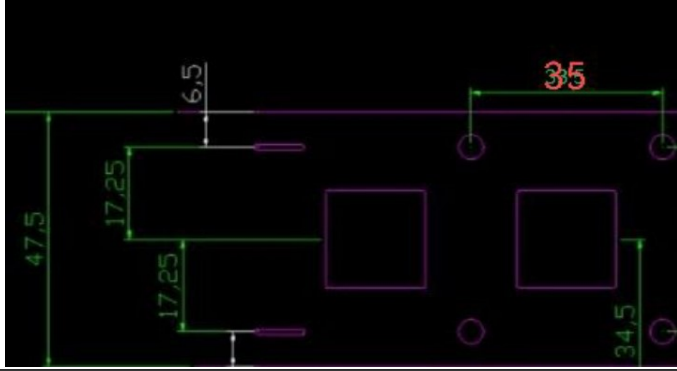
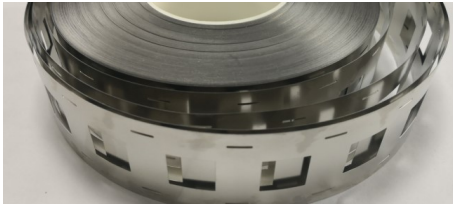

**Remark** | Material thickness optional: 0.1mm; 0.15mm; 0.2mm. Suitable for 32135/33135/33140 cell.

Name	Type	Center distance	Product material	Matching bracket
------	------	-----------------	------------------	------------------

Nickel Busbar	2P	Adjustable	Plated Nickel/Pure Nickel/Copper	Suitable for Square Cell
---------------	----	------------	----------------------------------	--------------------------

Product Image	Product Size (mm)
---------------	-------------------

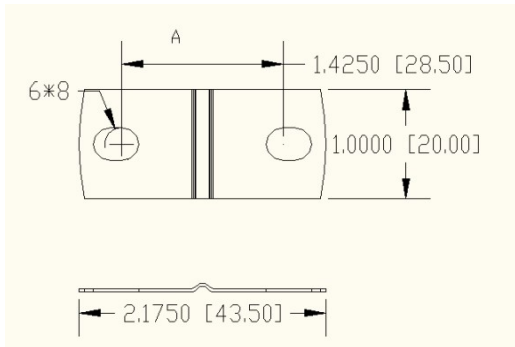

**Remark** | Size A is adjustable, with or without holes.